

**SERIES:** MD-XXSN | **DESCRIPTION:** MINI DIN CONNECTOR

**FEATURES**

- vertical
- panel mount
- thin metal mounting ears



**PART NUMBER KEY**

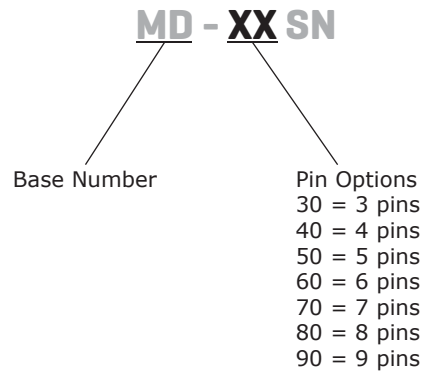

**SPECIFICATIONS**

| parameter             | conditions/description  | min | typ       | max    | units      |
|-----------------------|-------------------------|-----|-----------|--------|------------|
| rated input voltage   |                         |     | 100<br>12 |        | Vac<br>Vdc |
| rated input current   | at 100 Vac<br>at 12 Vdc |     |           | 1<br>2 | A<br>A     |
| contact resistance    |                         |     |           | 30     | mΩ         |
| insulation resistance | at 250 Vdc              | 50  |           |        | MΩ         |
| voltage withstand     | for 1 minute            |     |           | 250    | Vac        |
| insertion force       |                         |     |           | 4.5    | kg         |
| withdrawl force       |                         | 0.9 |           | 3      | kg         |
| operating temperature |                         | -20 |           | 105    | °C         |
| life                  |                         |     | 4,000     |        | cycles     |

## MECHANICAL DRAWINGS

units: mm[inches]

TOLERANCE: ±0.1mm

|                         | MATERIAL        | PLATING |
|-------------------------|-----------------|---------|
| shell (30~80)           | iron            | nickel  |
| shell (90)              | brass           | nickel  |
| contact terminals (1~9) | phosphor bronze | silver  |
| plastic                 | nylon + fiber   |         |

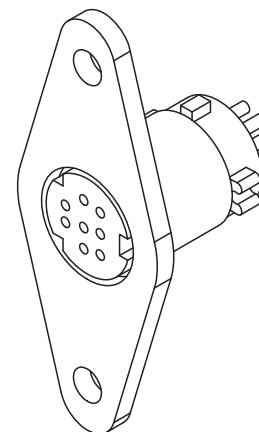
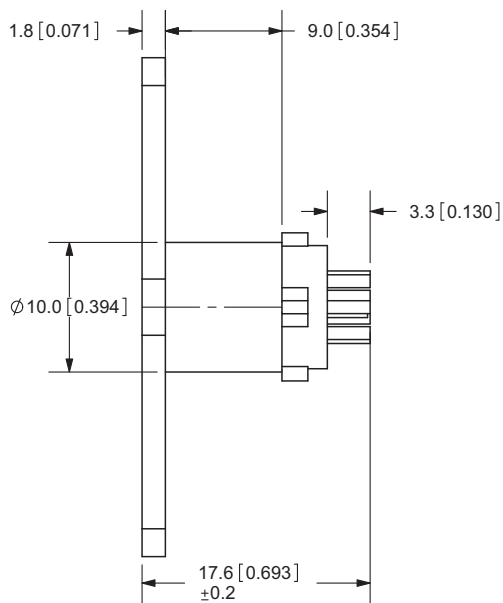
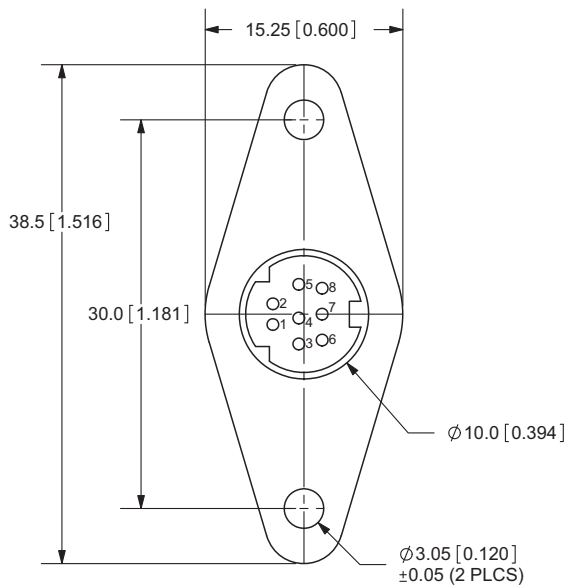

### MD-30SN

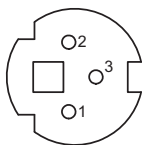

### MD-40SN

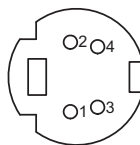

### MD-50SN

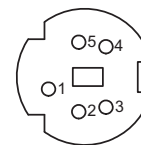

### MD-60SN

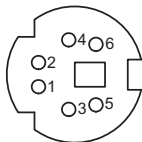

### MD-70SN

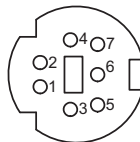

### MD-80SN

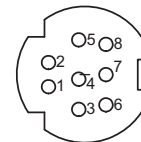

**MD-90SN**

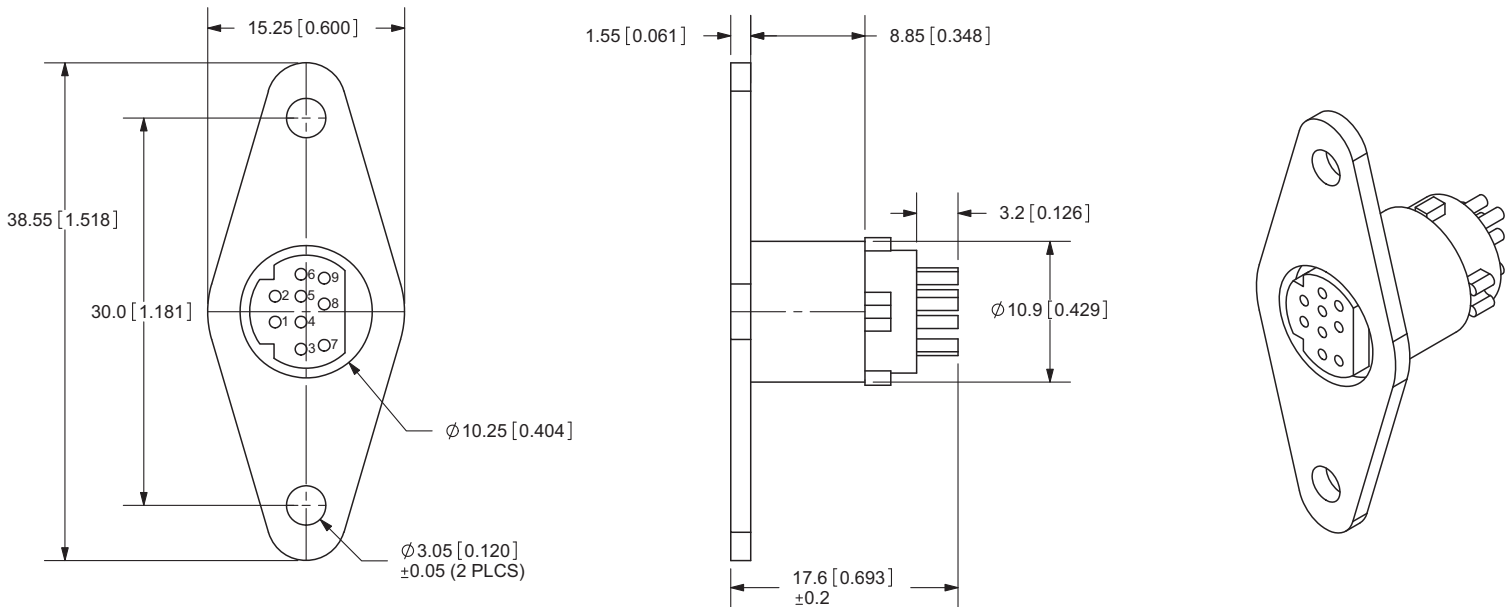

**REVISION HISTORY**

| rev. | description          | date       |
|------|----------------------|------------|
| 1.0  | initial release      | 04/07/2006 |
| 1.01 | new template applied | 05/02/2012 |
| 1.02 | housing updates      | 05/04/2012 |

The revision history provided is for informational purposes only and is believed to be accurate.



**Headquarters**  
 20050 SW 112th Ave.  
 Tualatin, OR 97062  
**800.275.4899**

Fax 503.612.2383  
**cui.com**  
 techsupport@cui.com

CUI offers a one (1) year limited warranty. Complete warranty information is listed on our website.

CUI reserves the right to make changes to the product at any time without notice. Information provided by CUI is believed to be accurate and reliable. However, no responsibility is assumed by CUI for its use, nor for any infringements of patents or other rights of third parties which may result from its use.

CUI products are not authorized or warranted for use as critical components in equipment that requires an extremely high level of reliability. A critical component is any component of a life support device or system whose failure to perform can be reasonably expected to cause the failure of the life support device or system, or to affect its safety or effectiveness.